

Panel-Loc Plus™ Product Guide

HELPFUL INFORMATION ON PANELS, TRIMS, GUTTERS AND ACCESSORIES

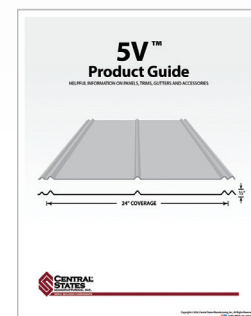

▲ This guide includes details for 5V.

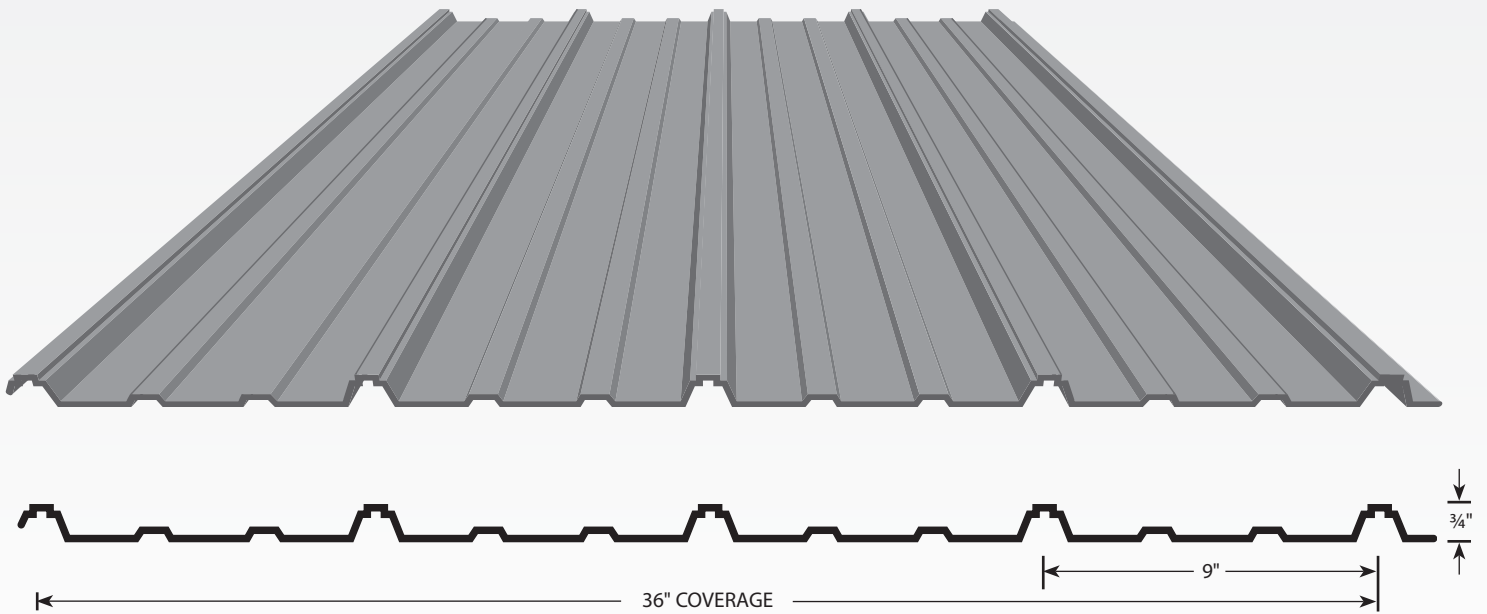

***We promise to improve your business
by accurately providing quality products
right when you need them. Every time.***

Visit our website for more product information, testing, installation guides, energy ratings, warranties, photo gallery, roofing visualizer, and more.

centralstatesco.com

INDEX

*Information in this catalog may vary by plant location.
Please call your salesperson to verify product availability.*

Panel-Loc Plus	
Panel Codes, Fastener Spacing, Section Properties	4-5
5V	
Panel Codes, Fastener Spacing	6
Care and Handling, Siphon Groove	7-8
Converting Pitch to Degree	9
Square Conversions	10
Gauge and Color Codes	11
Roof Trims	12-13
Wall Trims	13-14
Soffit/Fascia	15
Accessories	16-17

NOTICE: The application and detail drawings in this manual are strictly for illustration purposes and may not be applicable to all building designs or product installations. Projects should conform to local building codes. Central States Manufacturing is not responsible for the performance of the material if it is not installed correctly.

Information contained in this booklet was in effect at the time of publication and is subject to change without notice.

WARRANTIES



Warranties are available in paper format and downloadable from our website. After the job is complete, fill out a warranty with your contractor/installer details and the Central States order number. Give the warranty to the building owner to keep for their records. Optional warranty registration is available online.

Learn more at centralstatesco.com/warranties

PANEL-LOC PLUS

Panel-Loc Plus is available in Ultra 26 gauge, Prime 29 gauge, and Standard 29 gauge; in painted or bare Galvalume®. Ultra and Prime panels feature CentralGuard® protection and a lifetime paint warranty. Standard panels feature a 40-year paint warranty.

CentralGuard is our specific combination of everything that goes into making the highest-quality metal panels. Choose CentralGuard for the perfect balance of fade protection, rust blocking, and dent resistance.

Bare (unpainted) Galvalume® and galvanized panels from Central States have an acrylic coating which eliminates using oils during manufacturing and eliminates fingerprinting and foot marking during installation.

The minimum roof slope for the 3/4" Panel-Loc Plus™ is 2 1/2:12. If slopes less than 3:12 are needed, International Building Code (IBC) allows a sealant tape to be used on the laps of the panel.

PANEL CODES

PANEL PROFILE	TYPE	CODE
Panel-Loc Plus™	Ultra SMP	PP6(color)
Panel-Loc Plus™	Prime SMP/FEVE*	PP9(color)
Panel-Loc Plus™	Standard	PP9(color)ST

*FEVE = Flourinated Polymer Paint System

FASTENER SPACING

Follow the suggested fastener patterns below for interior or panel termination. Screws may be placed in either the flat or the rib. In the overlap condition, avoid using fasteners in the major rib as this may damage the siphon groove.

Fastener pattern at panel termination (Eave, endlap, valley, ridge, high eave)



Fastener pattern at interior of panel



SECTION PROPERTIES - PANEL-LOC PLUS

36" WIDE, PANEL-LOC PLUS™ PANEL

Gauge	Thickness (inches)	Weight (psf)	Yield Stress (ksi)	Top in Compression (Positive Bending)			Bottom in Compression (Negative Bending)		
				I _{xx}	S _{xx}	Ma	I _{xx}	S _{xx}	Ma
				in ⁴ /ft	in ³ /ft	in.kips/ft	in ⁴ /ft	in ³ /ft	in.kips/ft
26 ULTRA	0.0185	0.866	80.0	0.0133	0.0220	0.7913	0.0093	0.0198	0.7123
29 PRIME	0.0150	0.704	80.0	0.0110	0.0181	0.6493	0.0073	0.0160	0.5760

Section properties and allowables are calculated in accordance with 1996 AISI Specifications and 1999 AISI Supplement No. 1. I +/- is for deflection determination. S +/- is for bending determination. Ma is allowable bending moment. All values are for one foot of panel width. These loads are for panel strength. Frames, purlins, fasteners and all supports must be designed to resist all loads imposed on the panel. Allowable outward loads based on stress have been increased by 33.33% for wind uplift. Allowable loads for deflection are based on deflection limitation of span/180 or span/240. For roof panels, self weight of the panel has to be deducted from the allowable inward load to arrive at the actual "live load" carrying capacity of the panel. Minimum bearing length must be checked. Minimum deliverable bare steel thickness should not be less than 0.95 of design thickness.

THEORETICAL ALLOWABLE LIVE & WIND LOADS

SINGLE SPAN CONDITION

Span (feet)	29 Gauge & 80 ksi				26 Gauge & 80 ksi			
	LL (S)(psf)	LL (D) L/180(psf)	LL (D) L/240(psf)	WL(psf)	LL (S)(psf)	LL (D) L/180(psf)	LL (D) L/240(psf)	WL(psf)
2	108.2	108.2	90.1	127.7	131.9	131.9	109.3	157.9
2.5	69.3	61.5	46.2	81.7	84.4	74.6	55.9	101.1
3	48.1	35.6	26.7	56.7	58.6	43.2	32.4	70.2
3.5	35.3	22.4	16.8	41.7	43.1	27.2	20.4	51.6
4	27.1	15.0	11.3	31.9	33.0	18.2	13.7	39.5
4.5	21.4	10.6	7.9	25.2	26.1	12.8	9.6	31.2
5	17.3	7.7	5.8	20.4	21.1	9.3	7.0	25.3
6	12.0	4.5	3.3	14.2	14.7	5.4	4.0	17.5

TWO SPAN CONDITION

Span (feet)	29 Gauge & 80 ksi				26 Gauge & 80 ksi			
	LL (S)(psf)	LL (D) L/180(psf)	LL (D) L/240(psf)	WL(psf)	LL (S)(psf)	LL (D) L/180(psf)	LL (D) L/240(psf)	WL(psf)
2	96.0	96.0	96.0	121.0	118.7	118.7	118.7	175.4
2.5	61.4	61.4	60.1	77.5	76.0	76.0	72.8	112.3
3	42.7	42.7	34.8	53.8	52.8	52.8	42.2	78.0
3.5	31.3	29.2	21.9	39.5	38.8	35.4	26.5	57.3
4	24.0	19.6	14.7	30.3	29.7	23.7	17.8	43.9
4.5	19.0	13.7	10.3	23.9	23.5	16.7	12.5	34.6
5	15.4	10.0	7.5	19.4	19.0	12.1	9.1	28.1
6	10.7	5.8	4.3	13.4	13.2	7.0	5.3	19.5

THREE OR MORE SPAN CONDITION

Span (feet)	29 Gauge & 80 ksi				26 Gauge & 80 ksi			
	LL (S)(psf)	LL (D) L/180(psf)	LL (D) L/240(psf)	WL(psf)	LL (S)(psf)	LL (D) L/180(psf)	LL (D) L/240(psf)	WL(psf)
2	112.1	112.1	112.1	168.1	138.7	138.7	138.7	204.9
2.5	71.8	71.8	71.8	107.6	88.8	88.8	88.8	131.1
3	49.8	49.8	49.8	74.7	61.6	61.6	61.1	91.1
3.5	36.6	36.6	31.7	54.9	45.3	45.3	38.5	66.9
4	28.0	28.0	21.3	42.0	34.7	34.4	25.8	51.2
4.5	22.2	19.9	14.9	33.2	27.4	24.1	18.1	40.5
5	17.9	14.5	10.9	26.9	22.2	17.6	13.2	32.8
6	12.5	8.4	6.3	18.7	15.4	10.2	7.6	22.8

Theoretical allowable loads are based on uniform span lengths. LL (S) is allowable live load based on stress limitation. LL (D) is allowable live load based on deflection limitation of L/180 or L/240. WL is allowable wind load and has been increased by 33.33%.

5V™

5V is available in 26 ga. and 29 ga. bare Galvalume, or 29 ga. bare galvanized G90.

Bare (unpainted) Galvalume® and galvanized panels from Central States have an acrylic coating which eliminates using oils during manufacturing and eliminates fingerprinting and foot marking during installation.

Galvalume® features a 25-year AZ55 substrate warranty, but is not warranted for uniformity in appearance, whether it be color, sheen, or spangle. If the project requires a uniform appearance, please choose a painted product of a different profile.

The minimum roof slope for 5V is 3:12.

No load table available. Install 5V over solid decking with 30 lb. felt paper or equivalent.

PANEL CODES

PANEL PROFILE	TYPE	CODE
5V™	26 Ga. Galvalume®	5V6GL
5V™	29 Ga. Galvalume®	5V9GL
5V™	29 Ga. Galvanized G90	5V9ZNG90

Galvalume® is a registered trademark of BIEC International, Inc..

FASTENER SPACING

Follow the suggested fastener patterns below for interior or panel termination.

Fastener pattern at panel termination (Eave, endlap, valley, ridge)



Fastener pattern at interior of panel



DELIVERY

Deliveries will be made using a 65' tractor/trailer weighing approximately 80,000 lbs. It is imperative that all delivery locations be accessible by a vehicle of this size. Our drivers have the authority to refuse delivery to any location they see as unsafe or inaccessible. The customer is responsible

for any charges incurred if truck is detained for any reason. The customer is responsible for unloading all trucks. Any damage that occurs at this point is the customer's responsibility. There must be equipment available to unload the truck. Moffett deliveries require at least one person to assist with unloading.

CARE AND HANDLING

STAGE

Galvalume® steel panels have a good service life when exposed to normal weather conditions; however, to protect the appearance of panels and trims from damage, there are a few simple precautions that can be taken. The steel panels are subject to stain when water sits upon, or becomes trapped between the sheets. If the Galvalume® panels are to be stored for any period of time, they should be stored only in a dry place, preferably under a roof. Stand panels on end and fan them out at the bottom to provide air circulation and moisture run off. If space does not allow this, the panels should be separated, blocked off of the floor at least 12 inches to allow air flow, and stored at an incline to encourage drainage. The panels should then be covered, yet still have good air flow through the sheets to prevent condensation. Do not use a plastic cover, as this may cause the panels to sweat or condensation to occur.

STORAGE

Failure to follow these steps may result in wet storage stains and premature rusting. The manufacturer's warranty will be void at this time, and the manufacturer will not be responsible.

HANDLING

When unloading panels, extreme caution must be employed. Care needs to be used when unloading panels with a forklift. Panel edges and underside paint may become damaged if the forklift driver does not use caution. Once at the job site, care must be taken in order to protect the painted surface. When unbundling the panels, never drag them across the surface of one another. This may cause scratches across the underneath panels. It is recommended that the panels be "rolled" off the top of the bundle to prevent scratching. Never lift panels by the ends, instead lift the panels longitudinally and carry vertically.

Panel edges are very sharp, therefore, safety equipment should be worn by all workers handling the material.

Strippable film on Textured panels and trim must be removed within 30 days of manufacture date. Strippable that is left on for more than 30 days may be hard to peel off and is not a reason for a refund or replacement from the manufacturer.



CARE AND HANDLING

CUTTING

A portable field shear is the ideal method for cutting panels. Nibblers or a power shear may also be used. Although we do not recommend it, if you decide to cut with a saw, it is very important that the panels be turned upside down during cutting so that hot shavings do not come in contact with the painted surface. Make sure all adjacent panels are covered so that shavings are not imbedded in these panels. If metal shavings become imbedded in the paint surface, they will quickly rust. To avoid this, panels should be thoroughly wiped of all filings on both sides of the panel. Failure to comply with the recommended cutting procedures releases the manufacturer of any responsibility.

DRILLING

Panels should not be drilled while stacked. This will cause shavings that will become imbedded in the paint surface.



Shavings created by saw cutting or drilling may cause the panel to rust and will void warranties in affected areas.

SIPHON GROOVE

Panel-Loc Plus has two vertical edges, the overlap and the sidelap. The sidelap edge has a specific bend in the last major rib, called a siphon groove. When the overlap edge is installed on top of the sidelap edge, it creates an air gap that prevents water from wicking under the panel. Panels should be installed with the overlap facing away from the prevailing wind.

Do not damage the siphon groove by using a stitch screw on top of the major rib or clog it with butyl tape.

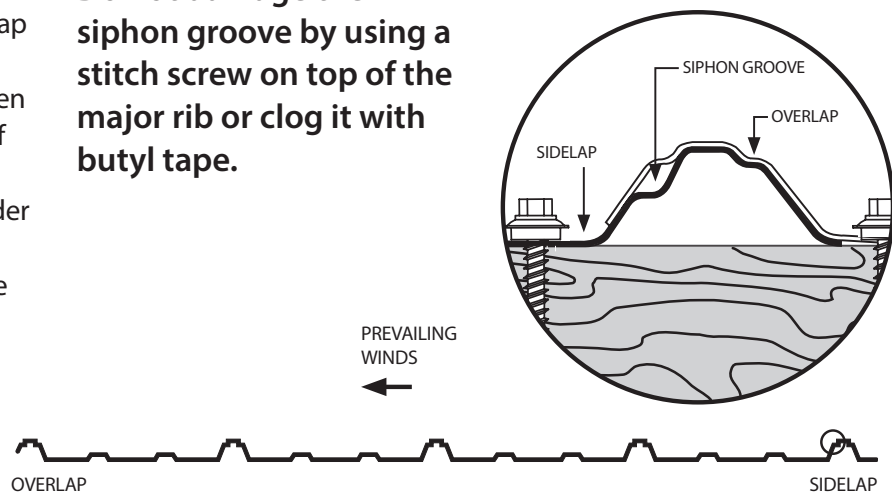

CONVERTING PITCH TO DEGREE

Use these charts to calculate degrees when designing custom trim.
Please specify pitch when ordering.

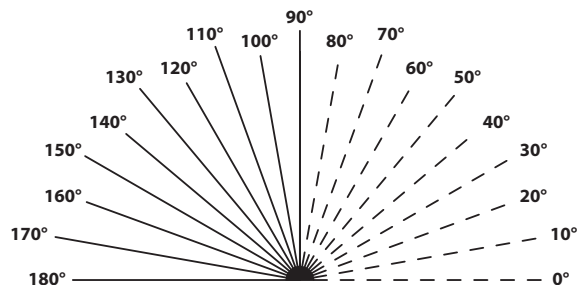
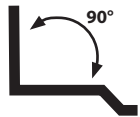
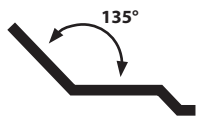

SINGLE SLOPE PITCHES

Fascia, Eave, Endwall, Tie-In, Gutter

1:12 PITCH	2:12 PITCH	3:12 PITCH	4:12 PITCH	5:12 PITCH	6:12 PITCH	7:12 PITCH	8:12 PITCH	9:12 PITCH	10:12 PITCH	11:12 PITCH	12:12 PITCH
94°	99°	104°	108°	112°	116°	120°	123°	126°	129°	132°	135°
173°	167°	160°	154°	148°	143°	138°	134°	130°	126°	123°	120°
170°	161°	152°	143°	135°	127°	120°	113°	106°	100°	95°	90°

DOUBLE SLOPE PITCHES

Hip, Valley

RIDGE CAP

TRANSITION TRIM

Find the box that intersects your lower and upper roof pitches.

If the intersection lands in the gray area, select a Lower Transition trim.

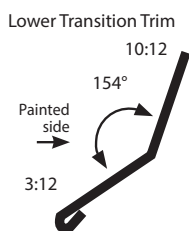
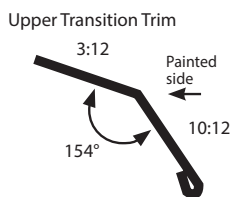

LOWER ROOF PITCH (INCHES OF RISE OVER 12" OF RUN)

	1:12 PITCH	2:12 PITCH	3:12 PITCH	4:12 PITCH	5:12 PITCH	6:12 PITCH	7:12 PITCH	8:12 PITCH	9:12 PITCH	10:12 PITCH	11:12 PITCH	12:12 PITCH	13:12 PITCH	14:12 PITCH	15:12 PITCH	16:12 PITCH	17:12 PITCH	18:12 PITCH
1:12 PITCH		175°	171°	166°	162°	158°	155°	151°	148°	145°	142°	140°	137°	135°	133°	132°	130°	128°
2:12 PITCH	175°		175°	171°	167°	163°	159°	156°	153°	150°	147°	144°	142°	140°	138°	136°	135°	133°
3:12 PITCH	171°	175°		176°	171°	167°	164°	160°	157°	154°	152°	149°	147°	145°	143°	141°	139°	138°
4:12 PITCH	166°	171°	176°		176°	172°	168°	165°	162°	159°	156°	153°	151°	149°	147°	145°	144°	142°
5:12 PITCH	162°	167°	171°	176°		176°	172°	169°	166°	163°	160°	158°	155°	153°	151°	149°	148°	146°
6:12 PITCH	158°	163°	167°	172°	176°		176°	173°	170°	167°	164°	162°	159°	157°	155°	153°	152°	150°
7:12 PITCH	155°	159°	164°	168°	172°	176°		177°	173°	170°	168°	165°	163°	161°	159°	157°	155°	154°
8:12 PITCH	151°	156°	160°	165°	169°	173°	177°		177°	174°	171°	169°	166°	164°	162°	161°	159°	157°
9:12 PITCH	148°	153°	157°	162°	166°	170°	173°	177°		177°	174°	172°	170°	167°	166°	164°	162°	161°
10:12 PITCH	145°	150°	154°	159°	163°	167°	170°	174°	177°		177°	175°	173°	170°	168°	167°	165°	163°
11:12 PITCH	142°	147°	152°	156°	160°	164°	168°	171°	174°	177°		178°	175°	173°	171°	169°	168°	166°
12:12 PITCH	140°	144°	149°	153°	158°	162°	165°	169°	172°	175°	178°		178°	176°	174°	172°	170°	169°

SQUARE CONVERSIONS

For 26 ga. and 29 ga. low rib panels there are 2 formulas; one for panels measured in inches and one for panels measured in feet. While the actual panel width is 38", there will only be 36" of coverage per panel. Squares are figured based on actual width. One square is equal to a panel 31.579 feet long. One square of metal will give you approximately 94.5 square feet of coverage. One square is equal to 14,400 square inches.

EXAMPLE USING INCHES:

38 (or width in inches) multiplied by length in inches
multiplied by # of pieces divided by 14,400

Number of panels = 12 $\frac{38" \times 144" \times 12}{14,400}$ equals 4.56 squares of metal
 Panel width = 38" 14,400
 Panel length = 144"
 Square inches = 14,400

EXAMPLE USING FEET:

length in feet multiplied by # of pieces
divided by 31.579*

Number of panels = 12 $\frac{12 \times 12}{31.579}$ equals 4.56 squares of metal
 Panel width = 38" 31.579
 Panel length = 12'

*For 26 ga. Thrifty Panel-Loc Plus or Panel-Loc, use 31.373 in place of 31.579.

COMMON RAFTER LENGTHS (PEAK TO SIDEWALL)

Running Feet	1:12 Pitch	2:12 Pitch	3:12 Pitch	4:12 Pitch	5:12 Pitch	6:12 Pitch
1	1' 0"	1' 1/8"	1' 3/8"	1' 5/8"	1' 1"	1' 1-3/8"
2	2' 1/8"	2' 3/8"	2' 3/4"	2' 1-1/4"	2' 2"	2' 2-7/8"
3	3' 1/8"	3' 1/2"	3' 1-1/8"	3' 2"	3' 3"	3' 4-1/4"
4	4' 1/8"	4' 5/8"	4' 1-1/2"	4' 2-5/8"	4' 4"	4' 5/8"
5	5' 1/4"	5' 7/8"	5' 1-7/8"	5' 3-1/4"	5' 5"	5' 7-1/8"
6	6' 1/4"	6' 1"	6' 2-1/4"	6' 3-7/8"	6' 6"	6' 8-1/2"
7	7' 1/4"	7' 1-1/8"	7' 2-5/8"	7' 4-1/2"	7' 7"	7' 9-7/8"
8	8' 3/8"	8' 1-3/8"	8' 3"	8' 5-1/4"	8' 8"	8' 11-3/8"
9	9' 3/8"	9' 1-1/2"	9' 3-3/8"	9' 5-7/8"	9' 9"	10' 3/4"
10	10' 3/8"	10' 1-5/8"	10' 3-3/4"	10' 6-1/2"	10' 10"	11' 2-1/8"
11	11' 1/2"	11' 1-7/8"	11' 4-1/8"	11' 7-1/8"	11' 11"	12' 3-5/8"
12	12' 1/2"	12' 2"	12' 4-3/8"	12' 7-3/4"	13' 0"	13' 5"
13	13' 1/2"	13' 2-1/8"	13' 4-3/4"	13' 8-1/2"	14' 1"	14' 6-3/8"
14	14' 5/8"	14' 2-3/8"	14' 8-1/8"	14' 9-1/8"	15' 2"	15' 7-7/8"
15	15' 5/8"	15' 2-1/2"	15' 5-1/2"	15' 9-3/4"	16' 3"	16' 9-1/4"
16	16' 5/8"	16' 2-5/8"	16' 5-7/8"	16' 10-3/8"	17' 4"	17' 10-5/8"
17	17' 5/8"	17' 2-7/8"	17' 6-1/4"	17' 11"	18' 5"	19' 1/8"
18	18' 3/4"	18' 3"	18' 6-5/8"	18' 11-5/8"	19' 6"	20' 1-1/2"
19	19' 3/4"	19' 3-1/8"	19' 7"	20' 3/8"	20' 7"	21' 2-7/8"
20	20' 7/8"	20' 3-3/8"	20' 7-3/8"	21' 1"	21' 8"	22' 4-3/8"
21	21' 7/8"	21' 3-1/2"	21' 7-3/4"	22' 1-5/8"	22' 9"	23' 5-3/4"
22	22' 7/8"	22' 3-5/8"	22' 8-1/8"	23' 2-1/4"	23' 10"	24' 7-1/8"
23	23' 1"	23' 3-3/4"	23' 8-1/2"	24' 3"	24' 11"	25' 8-5/8"
24	24' 1"	24' 4"	24' 8-7/8"	25' 3-5/8"	26' 0"	26' 10"
25	25' 1"	25' 4-1/8"	25' 9-1/4"	26' 4-1/4"	27' 1"	27' 11-3/8"
26	26' 1-1/8"	26' 4-1/4"	26' 9-1/2"	27' 5"	28' 2"	29' 3/4"
27	27' 1-1/8"	27' 4-1/2"	27' 9-7/8"	28' 5-5/8"	29' 3"	30' 2-1/4"
28	28' 1-1/8"	28' 4-3/4"	28' 10-1/4"	29' 6-1/4"	30' 4"	31' 3-3/4"
29	29' 1-1/4"	29' 4-7/8"	29' 10-5/8"	30' 6-7/8"	31' 5"	32' 5-1/8"
30	30' 1-1/4"	30' 5"	30' 11"	31' 7-1/2"	32' 6"	33' 6-1/2"
31	31' 1-3/8"	31' 5-1/8"	31' 11-3/8"	32' 8-1/8"	33' 7"	34' 7-7/8"
32	32' 1-3/8"	32' 5-1/4"	32' 11-3/4"	33' 8-3/4"	34' 8"	35' 9-1/4"
33	33' 1-1/2"	33' 5-1/2"	34' 1/8"	34' 9-3/8"	35' 9"	36' 10-3/4"
34	34' 1-1/2"	34' 5-3/4"	35' 1/2"	35' 10"	36' 10"	38' 1/4"
35	35' 1-1/2"	35' 5-7/8"	36' 7/8"	36' 10-5/8"	37' 11"	39' 1-5/8"

HOW TO ORDER TRIM

STEP 1:

In CentralLink™, start by entering the Item ID.

Item ID is made of the **TRIM CODE**, a **GAUGE CODE**, and a **COLOR CODE**.

The TRIM CODE can be found with each drawing next to the trim's name.

The GAUGE CODE and COLOR CODES are found below.

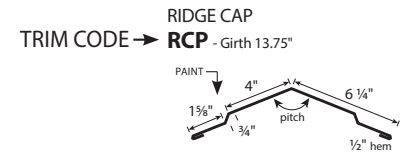

EXAMPLE: Ridge Cap, 26 gauge, Rustic

RCP **6** **RR**
TRIM CODE GAUGE CODE COLOR CODE

Enter Item ID

Description 26, Rustic, Ridge Cap

Pieces Feet Inches

STEP 2:

Then type the number of pieces you need along with the length in feet and inches.

CentralLink order screen

GAUGE CODES

GAUGE	CODE
26	6
29	9

COLOR CODES

SMP	PANEL GAUGE	TRIM GAUGE	CODE	TEXTURE SMP	PANEL GAUGE	TRIM GAUGE	CODE
Alamo	29/26	29	AW	Basil*	29	26	BA
Black	29/26	29/26	BK	Mineral*	29	26	MI
Brilliant	29/26	29/26	BI	Onyx*	29	26	OX
Brown	29/26	29/26	BR	Roma*	29	26	RM
Burgundy	29/26	29/26	BG	Sienna*	29	26	SI
Burnished Slate	29/26	29/26	BS	Sumatra*	29	26	SU
Charcoal	29/26	29/26	CH				
Colony	29	26	CG				
Copper Metallic**	29	29	CM				
Crimson	29/26	29/26	CR				
Desert	29	26	DS				
Forest	29/26	29/26	DG				
Gallery	29/26	29/26	GB				
Galvalume®	29/26	29/26	GL				
Galvanized	29	29	ZN				
Gray	29/26	29/26	GA				
Hawaiian		26	HB				
Hunter	29/26	29/26	GR				
Ivory	29	29	IV				
Light Stone	29/26	29/26	LS				
Ocean	29/26	29	OB				
Pewter	29	29	PG				
Polar		26	PW				
Rustic	29/26	29/26	RR				
Tan	29/26	29/26	TN				
Taupe	29/26	29/26	TA				

* Longer lead times may apply. ** Copper Metallic is Fluorpon®. Galvalume® is a registered trademark of BIEC International, Inc..

ROOF TRIMS

Unless otherwise noted, trims come in 29 or 26 gauge, and all angles are 90° or 45°. See page 11 for gauge and color codes.

RIDGE CAP - Specify pitch.

RIDGE CAP

RCP - Girth 13.75"

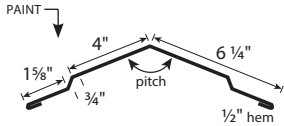

Recommended for 6:12 or less.

RIDGE CAP

RC2 - Girth 20.75"

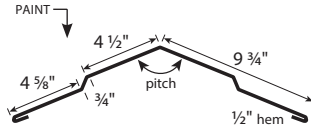

Recommended for all pitches.

RESIDENTIAL RIDGE CAP

RRCP - Girth 17"

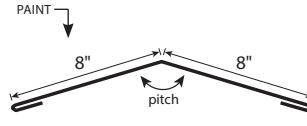

FORMED RIDGE CAP

PPFRCP - Length 3'

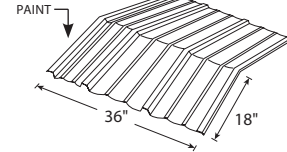

29 gauge only. Maximum pitch 4:12. Longer lead times may apply.

PEAK PLATE

PEAKP

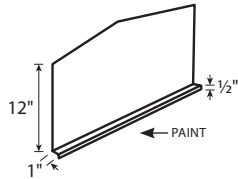

PEAK PLATE REVERSED

PEAKPREV

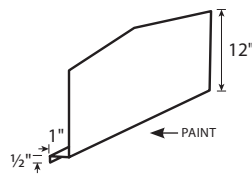

PEAK BOX

LRPBOXF - 13"

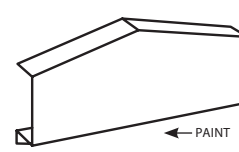

Standard 4:12.

HIP CAP

HIP - Girth 9"

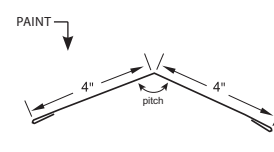

RAKE, GABLE, EAVE

RESIDENTIAL RAKE

RRT - Girth 10.75"

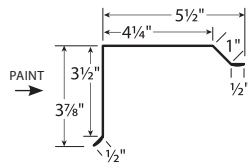

RAKE & CORNER

COR - Girth 13"

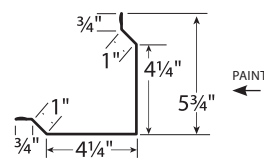

MINI RESIDENTIAL RAKE

RRTM - Girth 8"

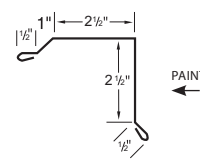

MINI CORNER

MCRN - Girth 9.5"

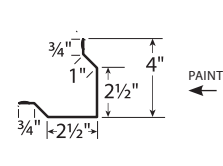

GABLE

GT6 - Girth 16.5"

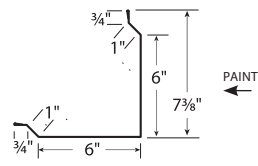

RESIDENTIAL EAVE

RET - Girth 6.5"

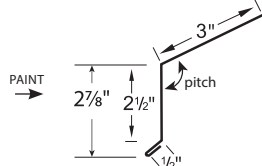

Specify pitch.

RESIDENTIAL DRIP EDGE

RDC - Girth 9.5"

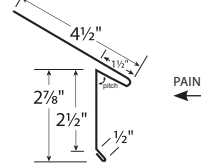

90° pitch if not specified.

FASCIA

FT - Girth 9"

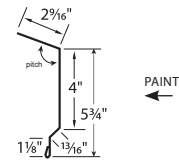

Specify pitch.

VALLEY

VALLEY

VT1 - Girth 19.75"

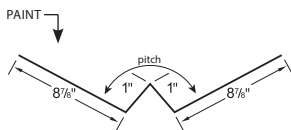

VALLEY

VT2 - Girth 20.75"

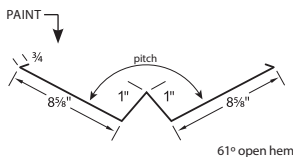

ROOF TRIMS

Unless otherwise noted, trims come in 29 or 26 gauge, and all angles are 90° or 45°. See page 11 for gauge and color codes.

TRANSITION TRIMS - Specify pitch.

GAMBREL TRIM UPPER
GTU - Girth 10.25"

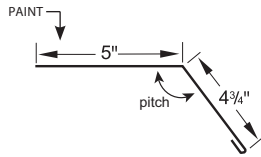

GAMBREL TRIM LOWER
GTL - Girth 10.25"

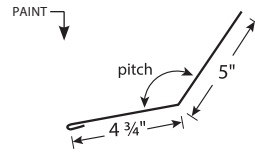

GAMBREL TRIM LOWER
GTL2 - Girth 14.5"

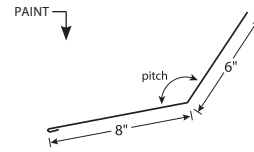

UNIVERSAL SIDEWALL
SF1 - Girth 9.25"

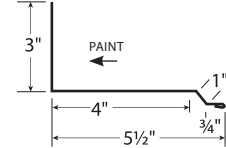

UNIVERSAL ENDWALL
EF - Girth 12.5"

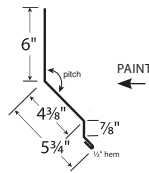

ENDWALL FLASHING
EFF - Girth 12"

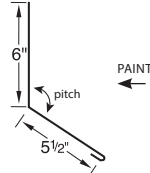

WALL TRIMS

Unless otherwise noted, trims come in 29 or 26 gauge, and all angles are 90° or 45°. See page 11 for gauge and color codes.

INSIDE CORNER
IC1 - Girth 13"

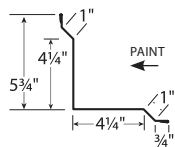

J-TRIM
JT - Girth 4.8125"

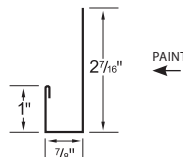

WINDOW DRIP CAP
WC - Girth 3.75"

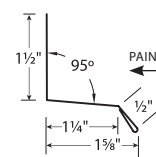

FLAT SHEET
FS9 - 29 gauge. Girth 43"
FS6 - 26 gauge. Girth 41.5625"

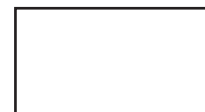

10 sheets or fewer will be packaged in a roll.
Additional pallet charge on orders of 10 or more.

RAKE & CORNER
COR - Girth 13"

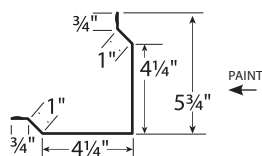

MINI CORNER
MCRN - Girth 9.5"

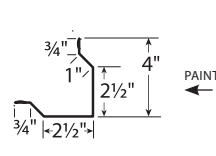

SQUARE BASE
SBA - Girth 5"

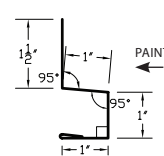

RAT GUARD
RG - Girth 4.75"
RG1 - Girth 5.5625"

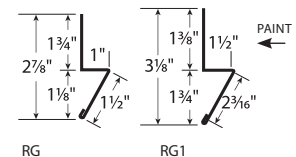

WALL TRIMS

Unless otherwise noted, trims come in 29 or 26 gauge, and all angles are 90° or 45°. See page 11 for gauge and color codes.

ANGLE

POST TRIM

- SA312** - Girth 5.5"
- SA512** - Girth 7.5"
- SA7** - Girth 9"
- SA712** - Girth 9.5"

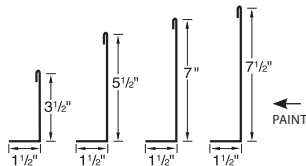

For hem on other leg, refer to Residential Fascia Trim.

INSIDE ANGLE

- IA112** - Girth 4"
- IA2X2** - Girth 5"
- IA3X3** - Girth 7"

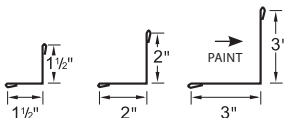

DOUBLE ANGLE

- DA1** - Girth 3.5"

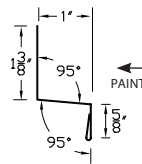

Use with wainscot.

WIDE DOUBLE ANGLE

- DA2** - Girth 4.5"

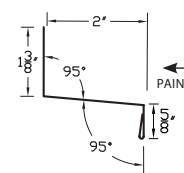

Use with wainscot.

SINGLE ANGLE

- SA112** - Girth 4"
- SA2X2** - Girth 5"
- SA3X3** - Girth 7"

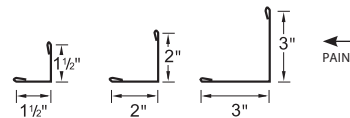

FRAMED OPENING TRIMS

OVERHEAD DOOR JAMB 7 1/8"

- OHDJ7** - Girth 12.5"

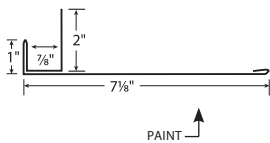

OVERHEAD DOOR JAMB 7 7/8"

- OHDJWD7** - Girth 12"

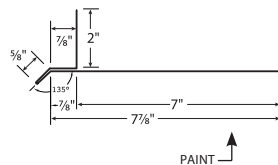

With drip edge.

OVERHEAD DOOR JAMB 9 1/4"

- OHDJ9** - Girth 14.25"

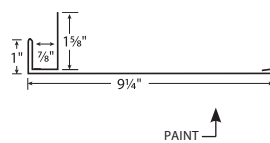

OVERHEAD DOOR JAMB 9 7/8"

- OHDJWD9** - Girth 14"

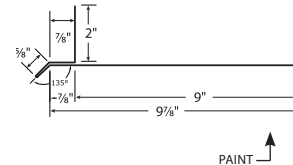

With drip edge.

DOOR POST TRIM

- DJ8** - Girth 12.5"

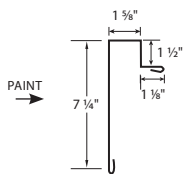

DOOR POST TRIM

- DJ9** - Girth 13.5"

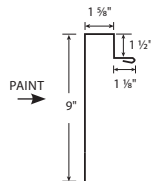

DOOR EDGE

- DJ10** - Girth 11.25"

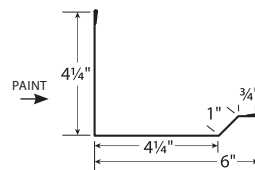

SLIDING DOOR TRIMS

TRACK DOOR JAMB

- TDJT** - Girth 14.375"

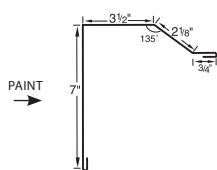

SQUARE TRACK COVER NATL

- NTC** - Girth 12.1875"
- NT2** - Girth 9.125"

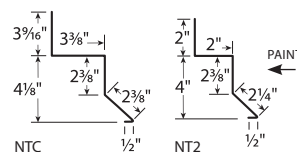

ROUND TRACK COVER

- CTC** - Girth 13"
- DC1** - Girth 17.625"

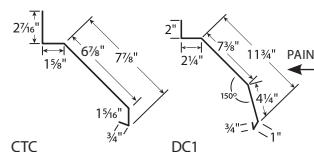

SOFFIT/FASCIA

Unless otherwise noted, trims come in 29 or 26 gauge, and all angles are 90° or 45°. See page 11 for gauge and color codes.

BEADED FASCIA
BFT9(color)102 - Girth 8.25"

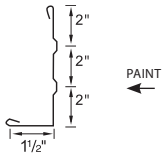

29 gauge only. Length 102"

RESIDENTIAL FASCIA TRIM
RFT312 - Girth 5.5"
RFT512 - Girth 7.5"
RFT712 - Girth 9.25"

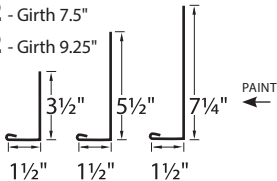

GABLE BASE SOFFIT
GB1 - Girth 20.25"

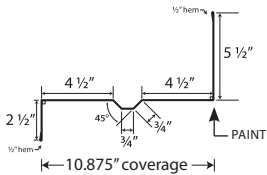

← 10.875" coverage →

SOFFIT F ADAPTOR
SFA - Girth 4.75"

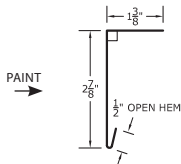

Random color. Use to make F&J Assembly.

J-TRIM
JT - Girth 4.8125"

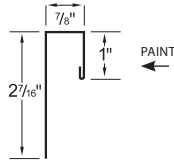

Use to make F&J Assembly.

F&J ASSEMBLY - (SFA & JT)

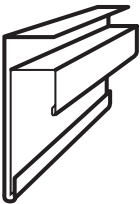

SOFFIT J-TRIM
SJT - Girth 3.625"

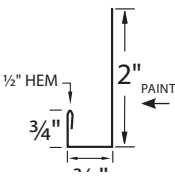

SOFFIT F&J
SFJ - Girth 9.375"

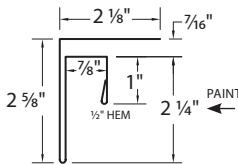

PANEL-LOC PLUS F&J
PFJ - Girth 9.125"

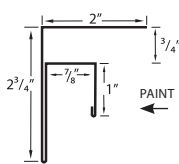

F CHANNEL
FC12 - Girth 7.5"
FC38 - Girth 7.375"

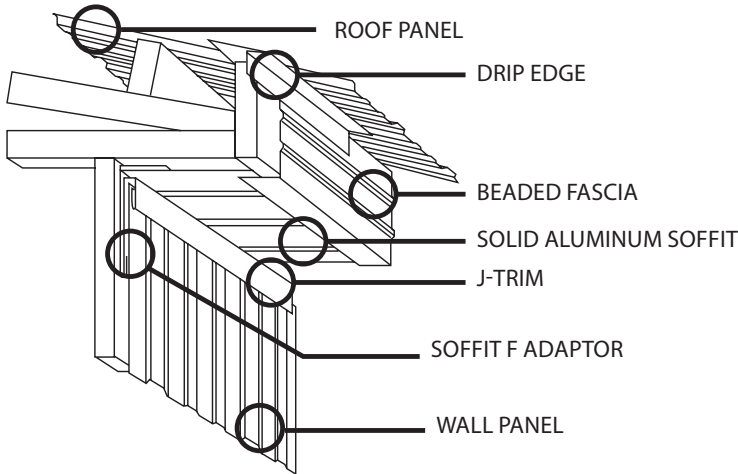
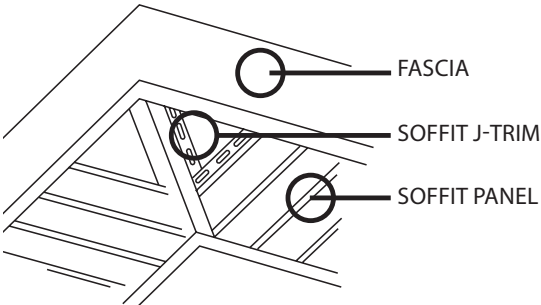
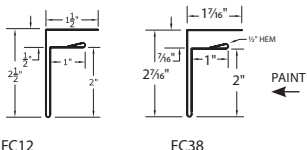

ACCESSORIES

BUTYL TAPE

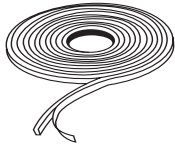

PART #	LENGTH	WIDTH	THICKNESS	ROLLS PER BOX
BT3/8 <i>Recommended for Panel-Loc Plus.</i>	45'	3/8"	3/32"	40
BTR	40'	7/8"	3/16"	10
BTL	45'	3/4"	3/32"	24

*Install between fastener and exposed edge.
Rolls per box may vary by location and vendor. Check with your sales person for details.*

SEALANT



PART #	SIZE	COLOR
GEO(color)	10.3 oz. tube	clear, gray, white
MRS10(color)	10.3 oz. tube	call for colors
MRS10CLEAR	10.3 oz. tube	clear

TOUCH UP PAINT

TP(color) - SMP, 0.6 oz. bottle w/brush.



DOOR SET - With steel jamb.

3068DR - 38" x 81 3/16"
KNOB

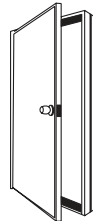

Door knobs sold separately.

PROFILE RIDGE VENT

PPVENT - Net free area 23.3 sq.in/ft

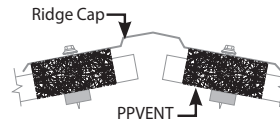

Length 100'. Width 3". Thickness 1".

FASTENERS

Fastener color availability may vary by location, contact your sales consultant for details. Order fasteners in increments of 250 pieces.

TYPE	PART #	LENGTH	DIAMETER	HEAD	COLOR	#BAG
METAL/WOOD	1(color)MW	1"	#10	1/4" Hex	all	250
METAL/WOOD	112(color)MW	1 1/2"	#10	1/4" Hex	all	250
METAL/WOOD	2(color)MW	2"	#10	1/4" Hex	all	250
METAL/WOOD	212(color)MW	2 1/2"	#10	1/4" Hex	all	250
METAL/WOOD	3(color)MW	3"	#10	1/4" Hex	all	250
METAL/WOOD STITCH	34(color)ST	3/4"	#12	1/4" Hex	all	250
METAL/METAL	34(color)MM	3/4"	#12	5/16" Hex	all	250
METAL/METAL	114(color)MM	1 1/4"	#12	5/16" Hex	all	250
METAL/METAL	2ZMM	2"	#12	5/16" Hex	galvanized	250
METAL/METAL LAP	78(color)LAP	7/8"	#14	5/16" Hex	all	250
LOW PROFILE WAFER HEAD	1WFAST	1"	#10	#2 Square drive	galvanized	250
POP RIVET	POP(color)		1/8"		ALL	100

ACCESSORIES

CLOSURES

- Sold separately or by the box.



Panel-Loc Plus outside closure shown.



Panel-Loc Plus inside closure shown.



Panel-Loc Plus closure vent shown.

INSIDE CLOSURE - Length - 3'. 100 per box.

PPCLIN Panel-Loc Plus

PPCLINGLUE Panel-Loc Plus - with adhesive

5VCLIN 5V - Length 2'.

OUTSIDE CLOSURE - Length - 3'. 100 per box.

PPCLOUT Panel-Loc Plus

PPCLOUTGLUE Panel-Loc Plus - with adhesive

5VCLOUT 5V - Length 2'.

CLOSURE VENT - Length - 3'. 25 rolls per box.

PPCLV Panel-Loc Plus

Closure is 1 3/8" tall and may require longer screws for installation. Item may vary from sample shown.

VERSAVENT

VERSA - 10' rolls per box.

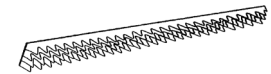

Length 10'. Width 3". Thickness 1 1/2".

RETRO-EASE RETROEASE



Length 300'.

GRAYFLEX
GRAYFLEX-6 - 24-rolls per box.

For use with hips and valleys.

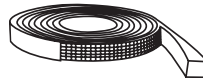

Length 20'. Width 1". Thickness 1".

UNIVERSAL POLYFOAM
POLYG - With glue. 10-rolls per box.



Length 25'. Width 1 1/2". Thickness 1 1/2".

FLEXOVENT
FLEXOVENT - (2) 10' rolls per box.

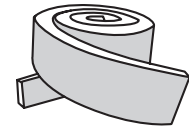

Length 10'. Width 3". Thickness 1 1/2".

SKYLIGHTS

- For best results, use approved sealant (MRS10SKY) and washer (118WASHER). Skylights should be predrilled.

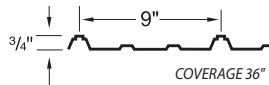

Panel-Loc Plus skylight shown.

Panel-Loc Plus - Clear Polycarbonate

PPSKYPCC8 - Length 8'.

PPSKYPCC10 - Length 10'.

PPSKYPCC12 - Length 12'.

Panel-Loc Plus - White Polycarbonate

PPSKYPCW8 - Length 8'.

PPSKYPCW10 - Length 10'.

PPSKYPCW12 - Length 12'.

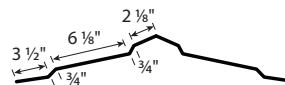

Skylight Ridge Cap - Universal

RCPC10 - Clear Polycarbonate

RCPCW10 - White Polycarbonate

Length 10'6". Width 25".

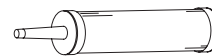

Skylight Sealant - Clear.

MRS10SKY 10.3 oz. tube

Approved for skylight use.



Skylight Washer - White.

118WASHER - 100 per bag.

3/8" outside diameter, 1/4" inside diameter

MASTER PIPE FLASHING

- Install in a diamond shape and not parallel to the rib.

Square - Max temperature 250°.

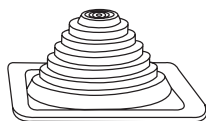

MPF - Pipe size .25" to 5"

MPF2 - Pipe size .25" to 3"

MPF4 - Pipe size 3" to 7"

MPF6 - Pipe size 4.75" to 10"

MPF7 - Pipe size 6" to 12"

MPF8 - Pipe size 6.75" to 14"

MPF9 - Pipe size 9.5" to 20.5"

Silicone - Orange, high temp max 500°.

4SMPF - Pipe size 2.75" to 7"

6SMPF - Pipe size 4.75" to 10"

8SMPF - Pipe size 6.75" to 13.5"

10SMPF - Pipe size 12" to 28.5"

Round - Gray

MPF3RG - Gray - Pipe size .25" to 5"

MPF5RG - Gray - Pipe size 4" to 7.5"

Square with zipper - Max temperature 250°.



MPF1ZIP - Pipe size .5" - 4"

MPF2ZIP - Pipe size 4" - 9.25"

Round - Black

MPF3RK - Black - Pipe size .25" to 5"

MPF5RK - Black - Pipe size 4" to 7.5"



Right.
On Time.
Every Time.®

centralstatesco.com